

GLOBAL EAST ASIA TECHNOLOGY CO.,LTD

<https://www.global-antenna.com>

Email: info@global-antenna.com

Tel: 86-371-58561629

GPS&GLONASS+LTE MIMO+WIFI MIMO×4 Antenna

GL604LMWM4



DIMENSIONS

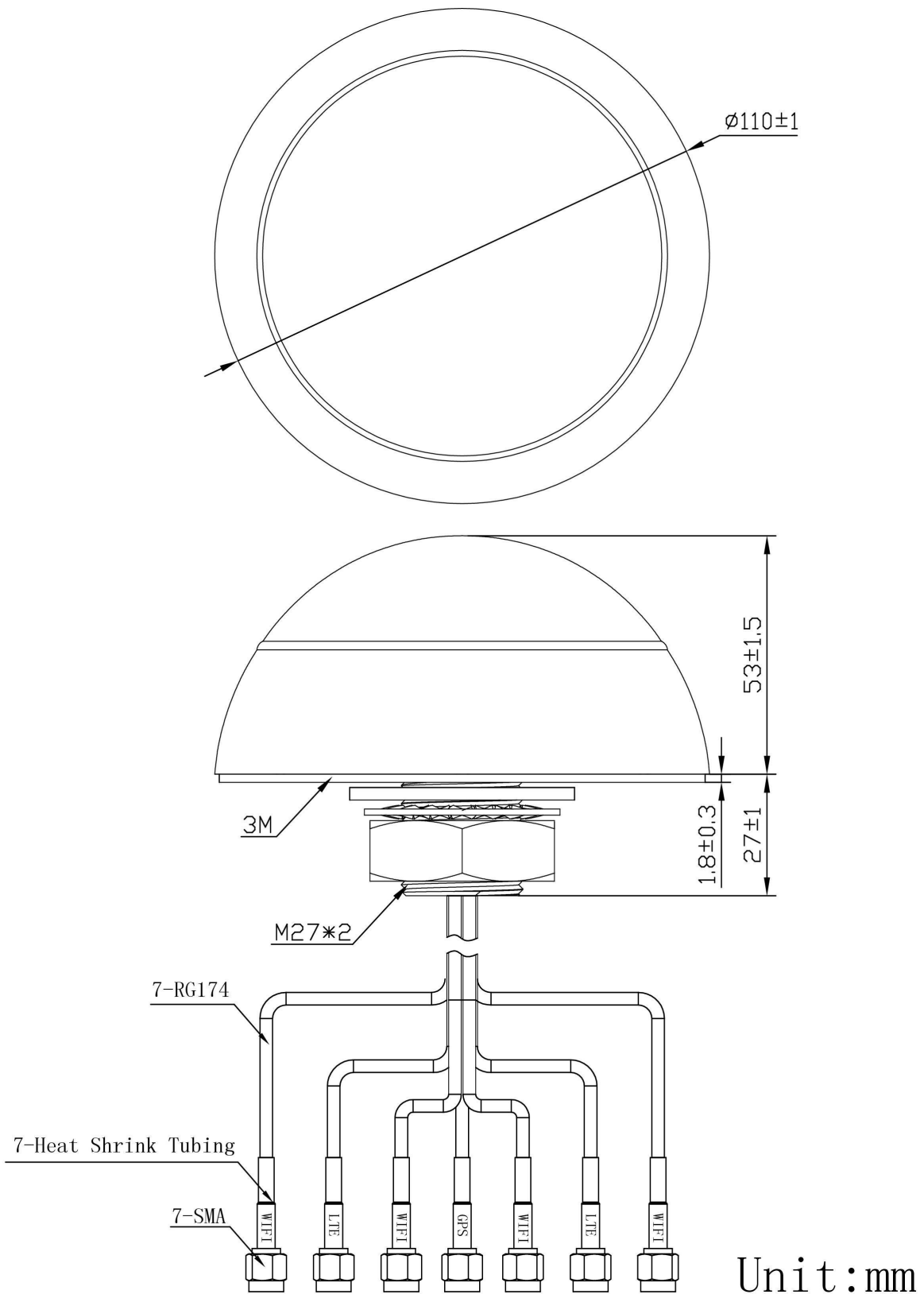

SPECIFICATIONS

Item	Specifications	
GPS&GLONASS Antenna	Frequency Range	1575.42~1610MHz
	Polarization	RHCP
	Impedance	50Ω
	Dimension	25*25*6mm
	Gain	28±2dB
	Noise Figure	≤1.5dB
	Supply Voltage	3~5V DC
	Current Consumption	<15mA
	V.S.W.R	<2.0
LTE Antenna MIMO	Frequency Range	698~960MHz/1710~2690MHz
	V.S.W.R	<3.0
	Polarization	Linear
	Gain	3dBi
	Impedance	50Ω
WIFI Antenna MIMO×4	Frequency Range	2400~2483.5MHz/4900~5825MHz
	V.S.W.R	<2.5
	Polarization	Linear
	Gain	2dBi
	Impedance	50Ω
Mechanical	Cable	RG174
	Connector	SMA or others
	Radome Material	ABS
	Mounting Method	Screw
Environmental	Operating Temperature	-40℃~+85℃
	Relative Humidity	Up to 95%
	Ingress Protection	IP67 (exclude cable outlet)
	Vibration	10 to 55Hz with 1.5mm amplitude 2hours
	Environmentally Friendly	ROHS Compliant

Radiation Pattern

GPS Antenna

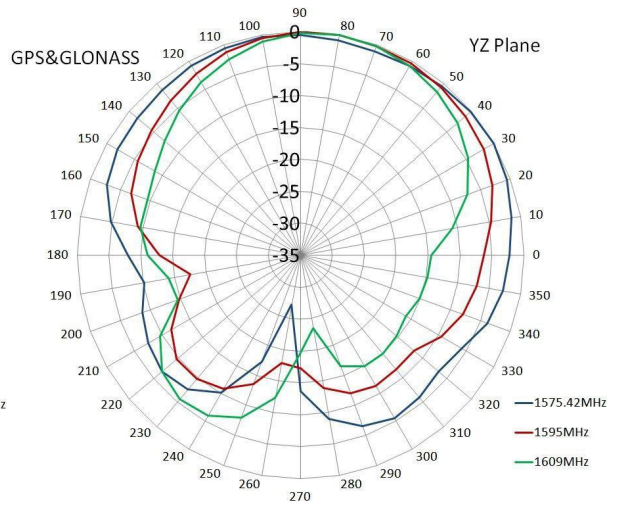
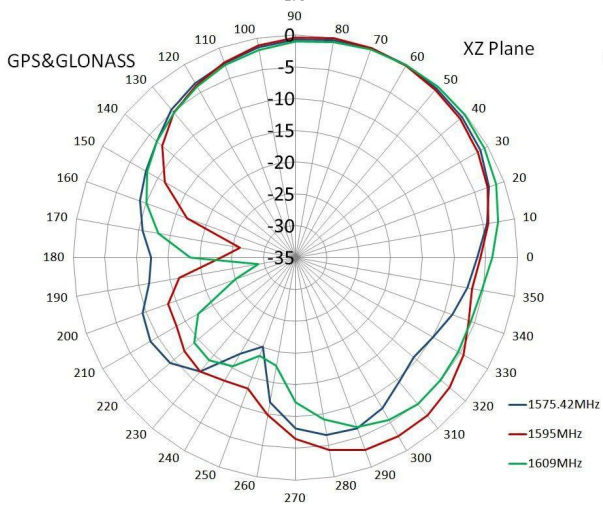
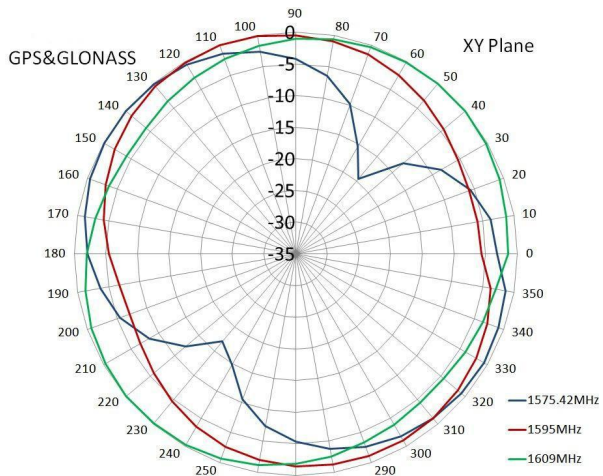

LTE Antenna

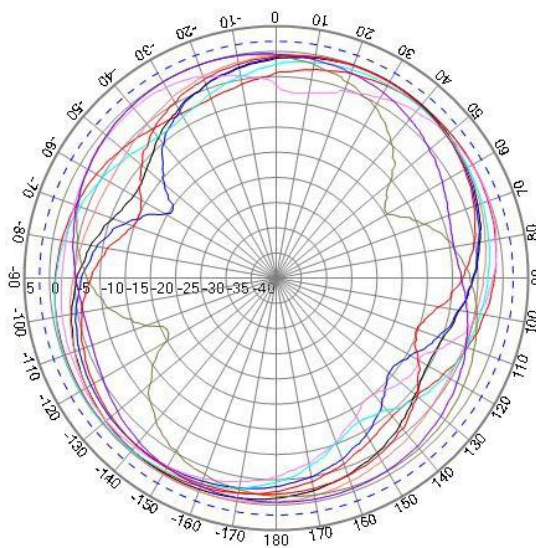

XY PLANE

- 测试频率: 700
- 测试频率: 824
- 测试频率: 868
- 测试频率: 960
- 测试频率: 1710
- 测试频率: 1850
- 测试频率: 1990
- 测试频率: 2170
- 测试频率: 2690

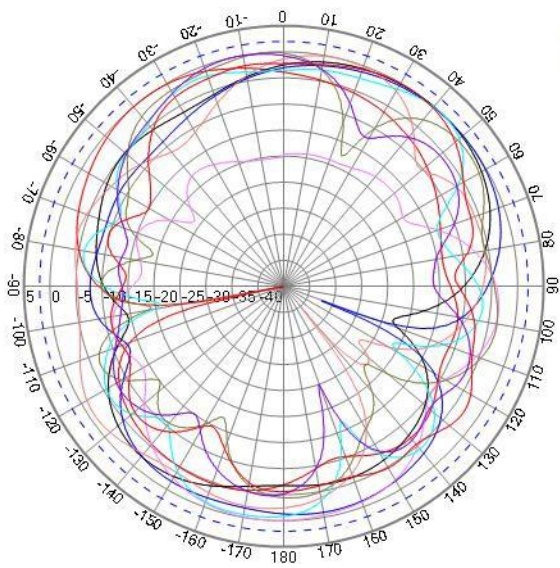

XZ PLANE

- 测试频率: 700
- 测试频率: 824
- 测试频率: 868
- 测试频率: 960
- 测试频率: 1710
- 测试频率: 1850
- 测试频率: 1990
- 测试频率: 2170
- 测试频率: 2690

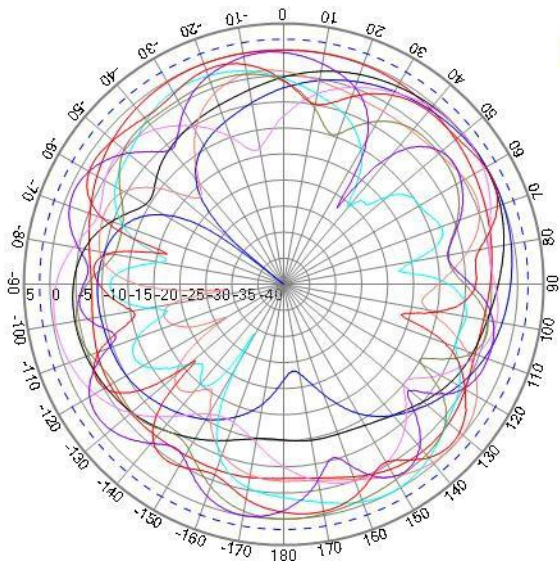

YZ PLANE

- 测试频率: 700
- 测试频率: 824
- 测试频率: 868
- 测试频率: 960
- 测试频率: 1710
- 测试频率: 1850
- 测试频率: 1990
- 测试频率: 2170
- 测试频率: 2690

WIFI Antenna

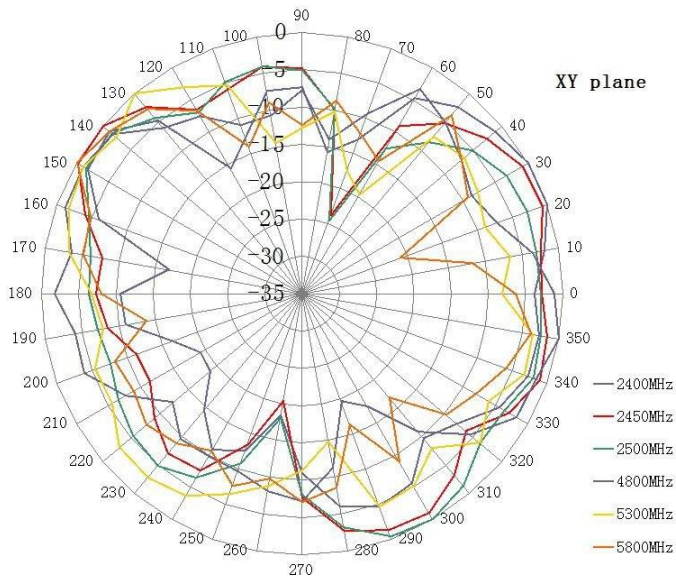

XY plane

